

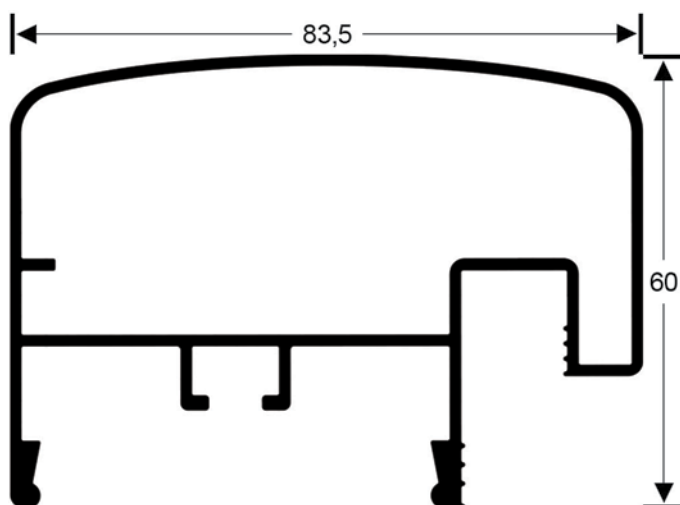

# PERFIS DE ALUMÍNIO

# GUARDA-CORPO

**MC-1083** | 1,459 kg/m



**MC-1075** | 0,540 kg/m

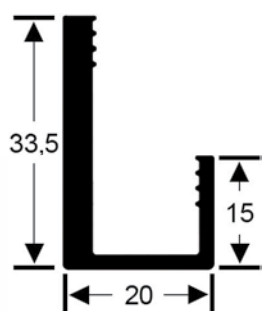

**MC-1077** | 0,864 kg/m

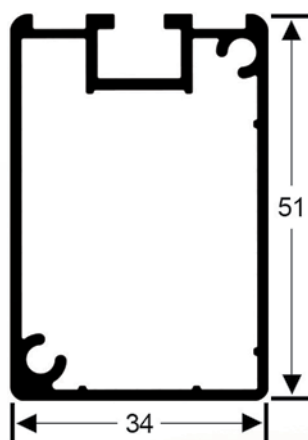

**MC-1074** | 0,301 kg/m

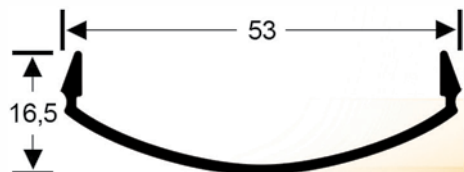

# FACHADA CORTINA

**MC-420** | 0,262 kg/m

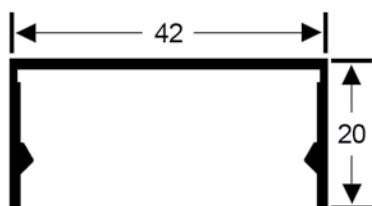

**MC-877** | 0,290 kg/m

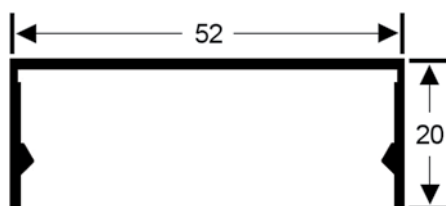

**MC-615** | 0,344 kg/m

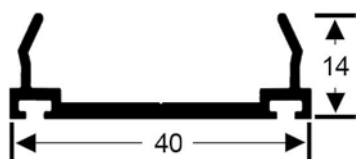

**MC-878** | 0,397 kg/m

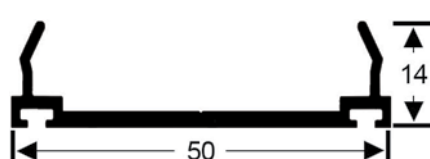

**MC-72** | 1,109 kg/m

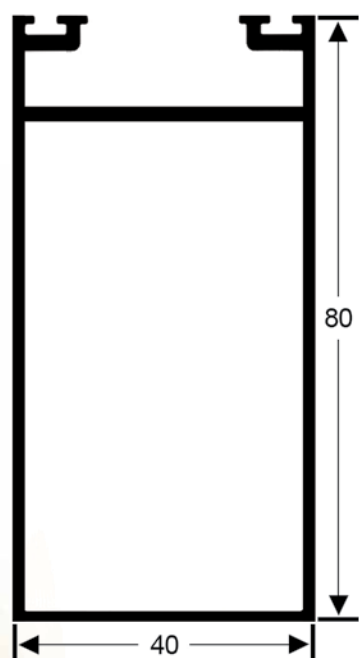

**MC-96** | 2,004 kg/m

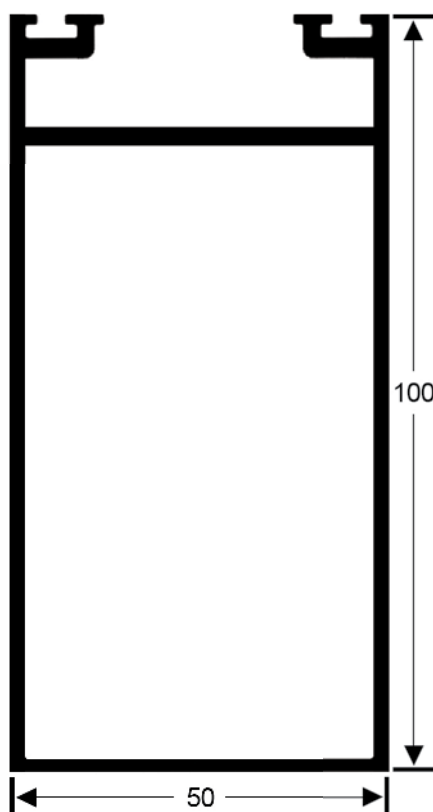

(11) 3924.2374

[www.silikone.com.br](http://www.silikone.com.br)

R. Padre Domingos Gava | nº 288 | CEP 02841.030  
Pq. São Puiz | São Paulo | SP

# INSTALAÇÃO 10 mm

**MC-1** | 1,303 kg/m

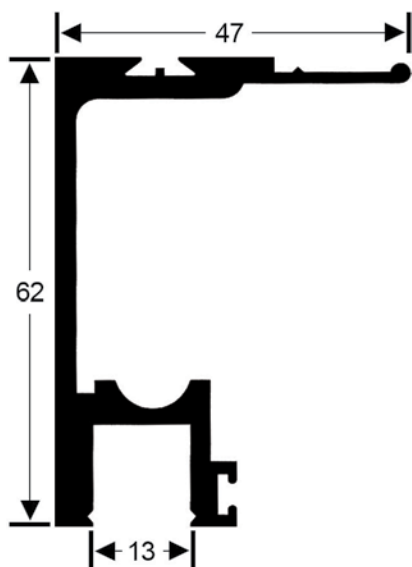

**MC-2** | 0,404 kg/m

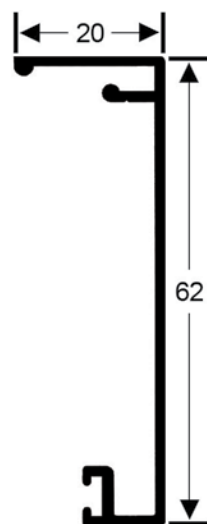

**MC-14** | 0,151 kg/m

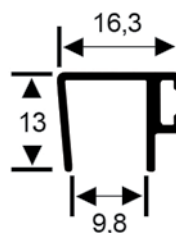

**MC-13** | 0,078 kg/m

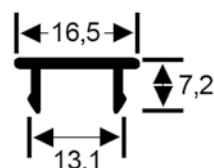

**MC-51** | 0,963 kg/m

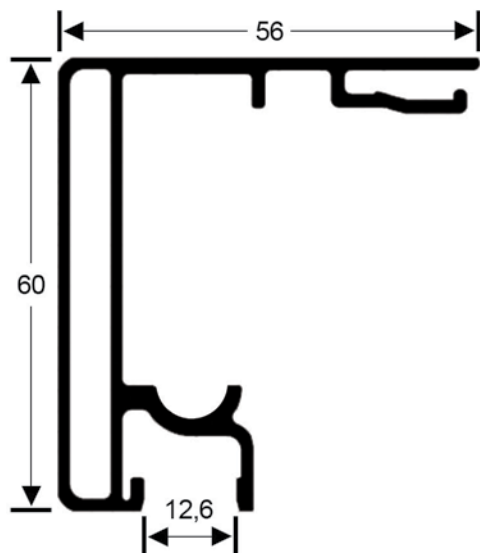

**MC-52** | 0,243 kg/m

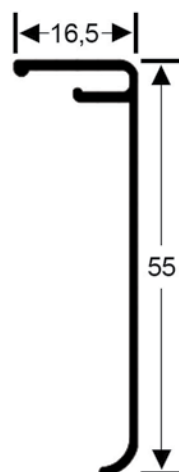

**MC-5** | 0,440 kg/m

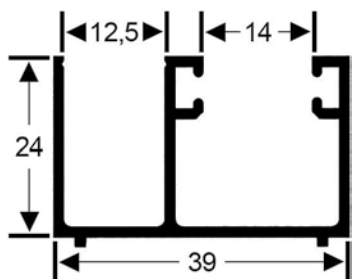

**MC-10** | 0,209 kg/m

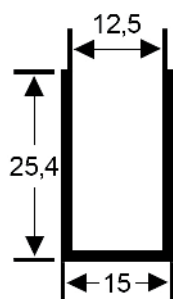

**MC-17** | 0,169 kg/m

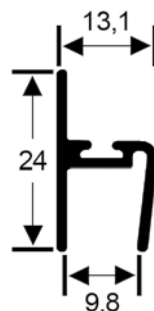

# DIVERSOS

**MC-10** | 0,209 kg/m

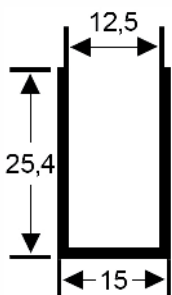

**MC-93** | 0,115 kg/m

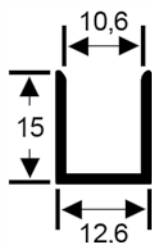

**MC-12** | 0,156 kg/m

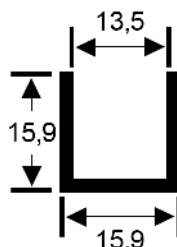

**MC-26** | 0,253 kg/m

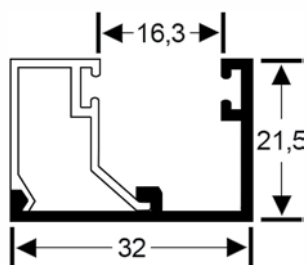

**MC-27** | 0,172 kg/m

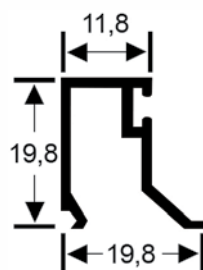

**MC-66** | 0,147 kg/m

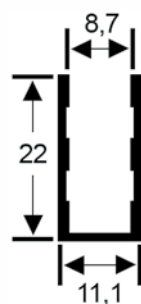

**MC-333** | 0,628 kg/m

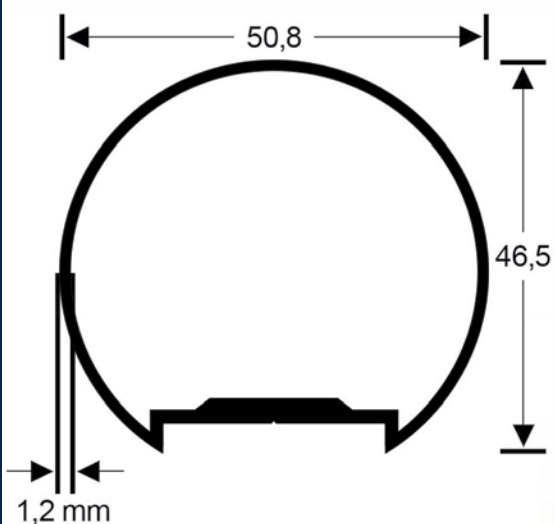

**MC-264** | 0,129 kg/m

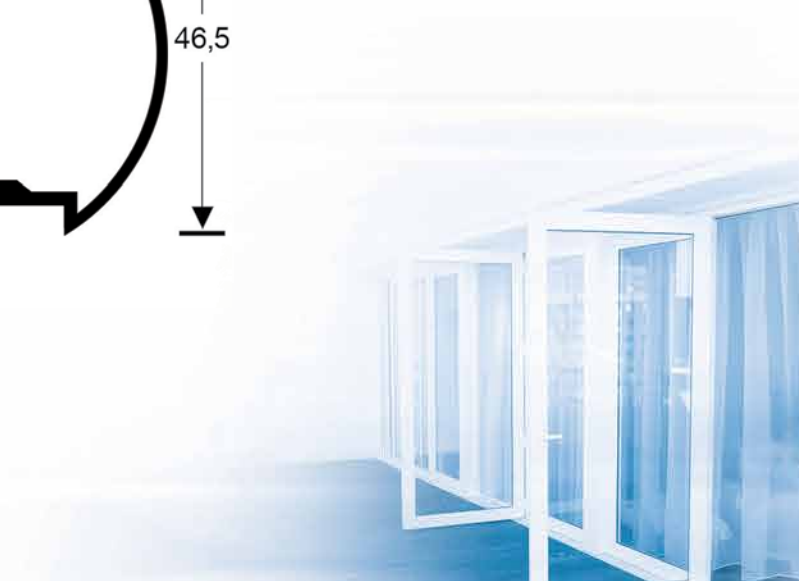
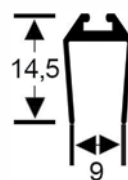

**MC-225** | 0,130 kg/m

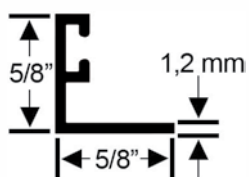

**MC-92** | 0,083 kg/m

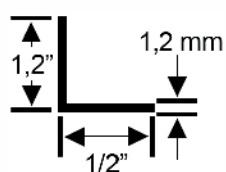

**MC-91** | 0,105 kg/m

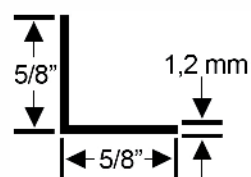

**MC-254** | 0,372 kg/m

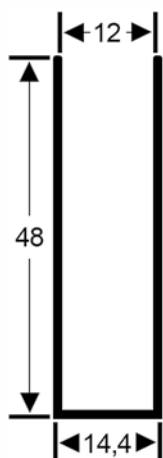

**MC-90** | 0,166 kg/m

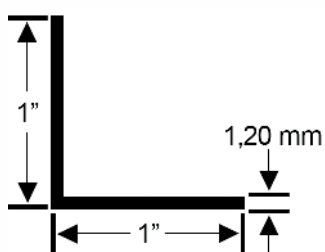

**MC-6** | 0,304 kg/m

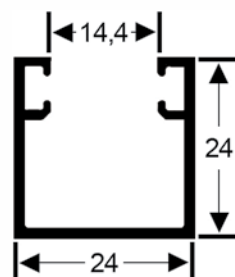

**MC-69** | 0,564 kg/m

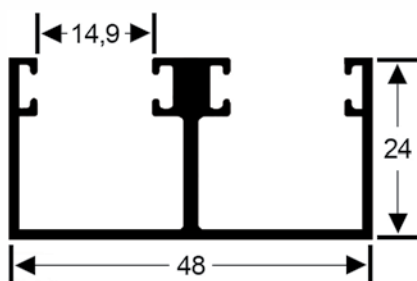

**MC-68** | 1,366 kg/m

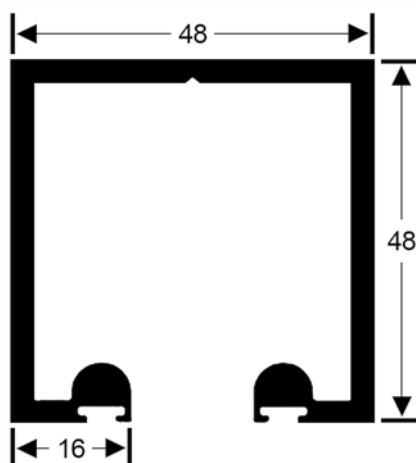

**MC-260** | 0,154 kg/m

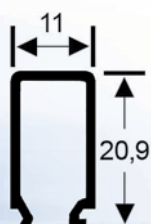

**MC-259** | 0,149 kg/m

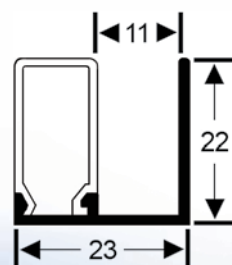

# INSTALAÇÃO 8 mm

**MC-49** | 0,709 kg/m

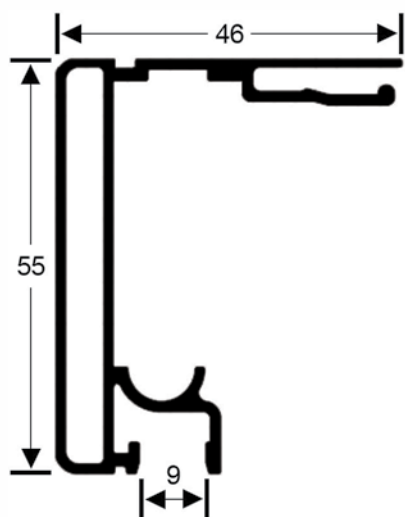

**MC-50** | 0,243 kg/m

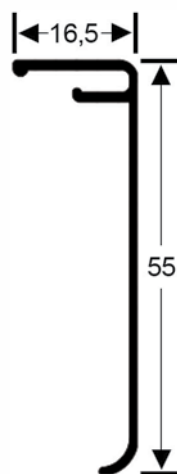

**MC-75** | 0,364 kg/m

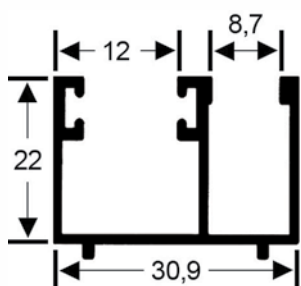

**MC-66** | 0,147 kg/m

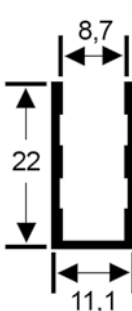

**MC-65** | 0,060 kg/m

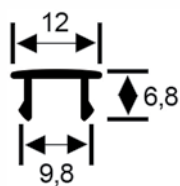

**MC-46** | 0,116 kg/m

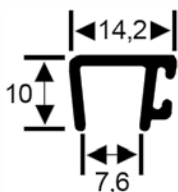

**MC-47** | 0,143 kg/m

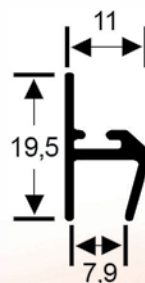

# TUBOS

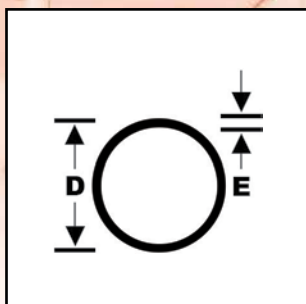
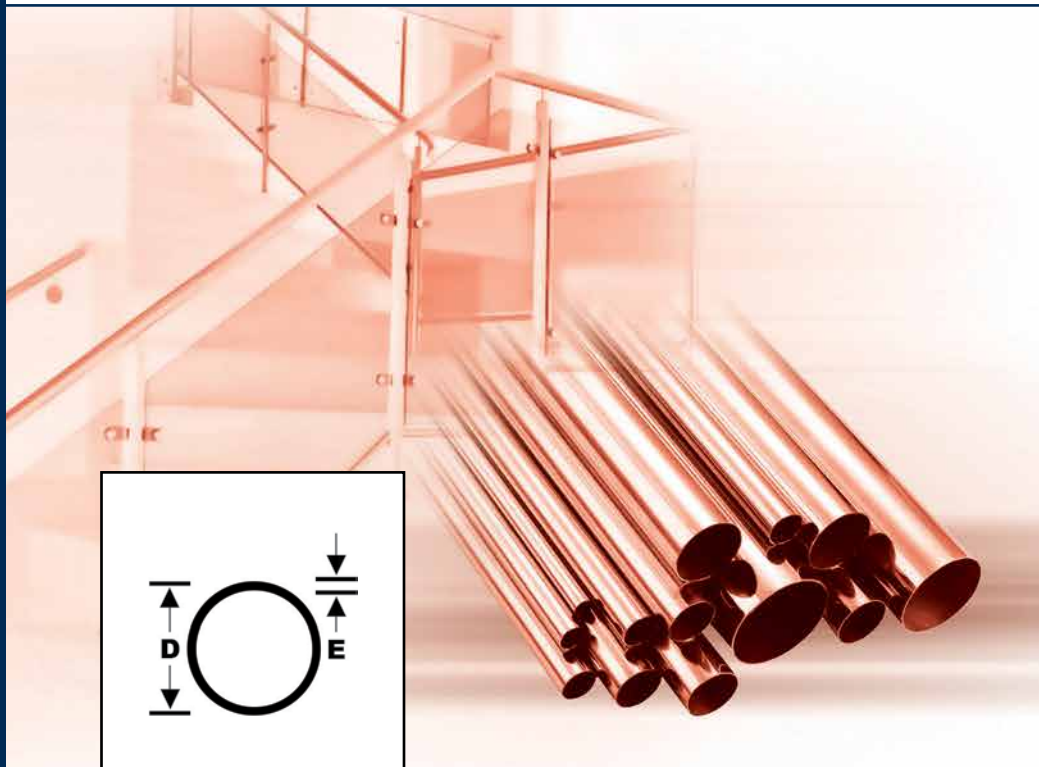

CÓDIGO	Peso / ml	D		E
		Polegada	Milímetro	
MC-105	0,625	2"	50,8	1,4 mm

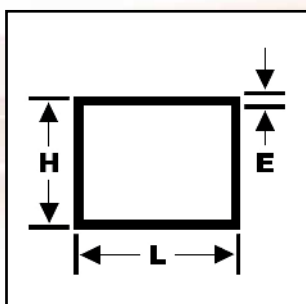

CÓDIGO	Peso / ml	L		H		E
		Polegada	Milímetro	Polegada	Milímetro	
MC-101	0,494	2"	50,8	1"	25,4	1,2 mm
MC-100	0,850	2"	50,8	2"	50,8	1,5 mm
MC-103	0,932	3"	76,2	1,1/2"	38,1	1,5 mm
MC-102	1,288	4"	101,6	2"	50,8	1,5 mm
MC-104	0,421	2"	50,8	1/2"	12,7	1,2 mm